



SMD Multilayer Ferrite Chip Beads-HHFJ Series

FEATURES

- * Product symbol: HSB, HGB, HPB, HUPB, HNB, HF, HVPB
- * Packaging: T: Tape and Reel; B: Bulk
- * Tolerance: Y = $\pm 25\%$; M = $\pm 20\%$; T: $\pm 30\%$
- * Note: RoHS Compliant



ORDERING CODE(标志示例)

HHFJ □□□□ - □□□ □
(1) (2) (3) (4)

- (1) HFJ 向华料号 Part Number
- (2) 尺寸 Dimensions
- (3) 电感量 Inductance
- (4) 电感量公差 Inductance Tolerance

Shape and Dimensions

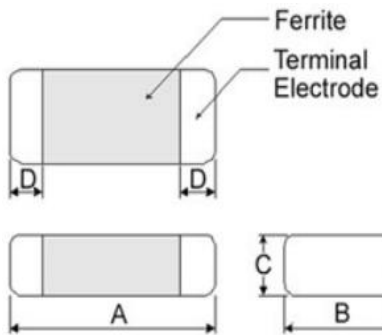

Recommended Pattern

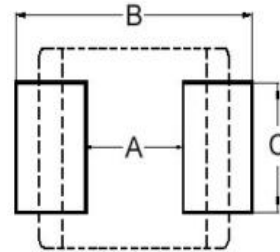

Dimensions in mm

TYPE	A	B	C	D
①060303	0.6 \pm 0.03	0.30 \pm 0.03	0.3 \pm 0.03	0.15 \pm 0.05
②100505	1.0 \pm 0.10	0.50 \pm 0.10	0.5 \pm 0.10	0.25 \pm 0.10
③160805	1.6 \pm 0.15	0.80 \pm 0.15	0.5 \pm 0.15	0.3 \pm 0.2
④160808	1.6 \pm 0.15	0.80 \pm 0.15	0.8 \pm 0.15	0.3 \pm 0.2
⑤201209	2.0 \pm 0.20	1.25 \pm 0.20	0.9 \pm 0.20	0.5 \pm 0.3
⑥321611	3.2 \pm 0.20	1.60 \pm 0.20	1.1 \pm 0.20	0.5 \pm 0.3

TYPE	A	B	C
①060303	0.2~0.3	0.75~1.05	0.30
②100505	0.40	1.2~1.4	0.50
③160805	0.7~0.8	1.8~2.0	0.6~0.8
④160808	0.7~0.8	1.8~2.0	0.6~0.8
⑤201209	1.0~1.2	2.6~4.0	1.0~1.2
⑥321611	2.00	4.2~5.2	1.20

Dimension Conversion

Code	Dimension in mm (A×B×C)	EIA
060303	0.6X0.3X0.3	0201
100505	1.0X0.5X0.5	0402
160805	1.6X0.8X0.5	0603
160808	1.6X0.8X0.8	0603
201209	2.0X1.2X0.9	0805
321611	3.2X1.6X1.1	1206



SMD Multilayer Ferrite Chip Beads-HHFJ100505 Series

HHFJ100505 series Electrical Characteristics

Part No.	Impedance (Ω)	Tolerance ($\pm\%$)	Test Freq. (MHz)	RDC (Ω)Max	Rated current (mA)Max
HHFJ100505T-601Y	600	25	100	0.85	300
HHFJ100505T-102Y	1000	25	100	1.25	250
HHFJ100505T-152Y	1500	25	100	1.80	230
HHFJ100505T-182Y	1800	25	100	2.20	200

Note: When ordering, please specify tolerance code. Tolerance : Y= $\pm 25\%$

- Operating temperature range $-55^{\circ}\text{C} \sim 125^{\circ}\text{C}$ (Including self - temperature rise)
- Rate Current: Applied the current to coils, the temperature rise shall not be more than 30°C

Test Instruments: Agilent E4991A Impedance / Material Analyzer

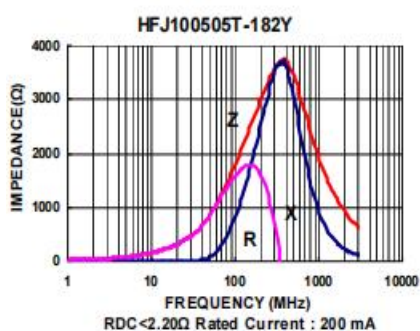
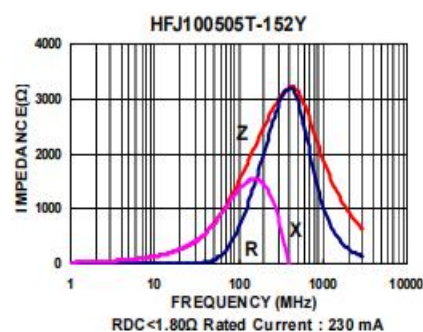
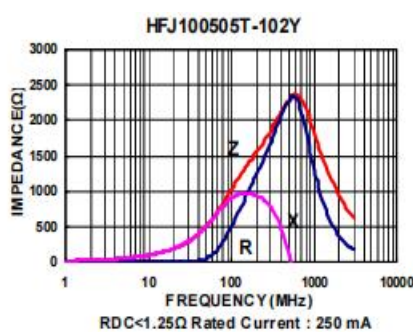
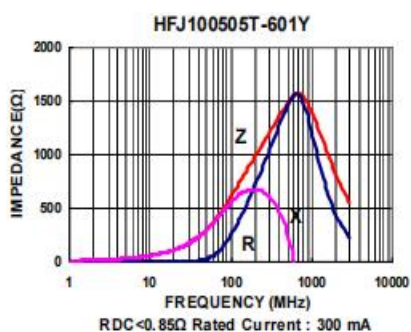

Please be sure to request approval specifications that provide further details of the products. Kindly note that the content of these specifications are subject to change or may be discontinued without advance notice. Please contact our sales department before ordering.



SMD Multilayer Ferrite Chip Beads-HHFJ Series

Packaging Specifications

Tape Dimensions

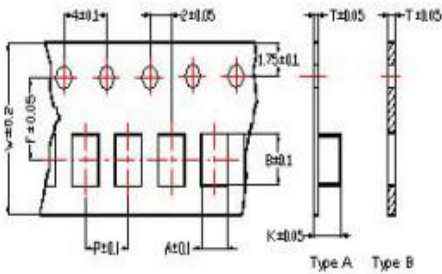

Tape Material

Carrier Tape: Polycarbonate (Tape A)
Carrier Tape: Paper (Tape B)
Cover Tape: Polystyrene

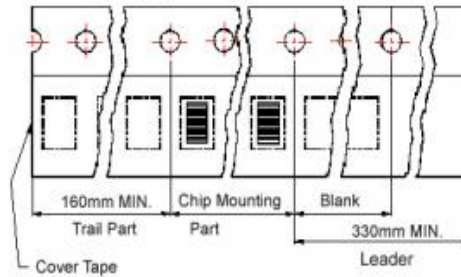

Reel Dimensions

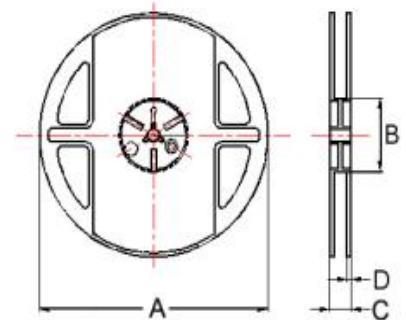

- ① : HSBY / HSBJ / HNB / HPB
- ② : HSBY / HSBJ / HNB / HPB / HUPB / HF
- ③ : HUPB
- ④ : HSBK / HSBJ / HGB / HPB / HNB / HUPB / HVPB
- ⑤ : HSBK / HGB / HPB / HUPB
- ⑥ : HSBY / HSBK / HPB / HUPB

Dimensions in mm

TYPE	Tape Dimensions								Reel Dimensions				Quantity PCS/REEL
	A	B	T	W	P	F	K	Tape	A	B	C	D	
①060303	0.37	0.67	0.42	8.0	2.0	3.5	--	B	178	60	10	2	15000
②100505	0.62	1.12	0.60	8.0	2.0	3.5	--	B	178	60	12	2	10000
③160805	1.05	1.85	0.60	8.0	2.0	3.5	--	B	178	60	12	2	10000
④160808	1.05	1.85	0.95	8.0	4.0	3.5	--	B	178	60	12	2	4000
⑤201209	1.50	2.30	0.97	8.0	4.0	3.5		B	178	60	12	2	4000
⑥321611	1.88	3.50	0.22	8.0	4.0	3.5	1.27	A	178	60	12	2	3000